

TRANSITIONS, DAMPERS, & ADAPTORS

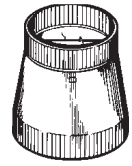

- Model 411 Transition**
 ● 3¼" x 10" to 6" round
Model 412H Transition
 ● 3¼" x 10" to 7" round
Model 413 Transition
 ● 3¼" x 10" to 8" round

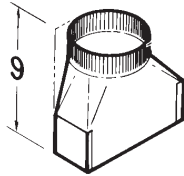

All models above -
 30 GA galvanized steel
 construction

- Model 423 Transition**
 ● 4½" x 18½" to 10" round
 – vertical discharge
 ● 26 GA galvanized steel

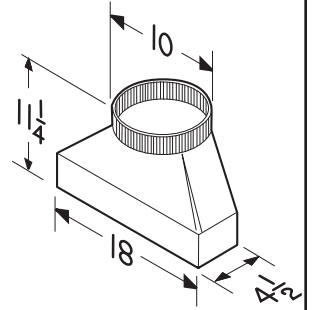

- Model 414 Transition**
 ● 10" round to 8" round
 ● 24 GA galvanized steel

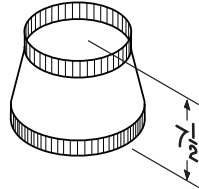

- Model 424 Transition**
 ● 4½" x 18½" to 10" round
 – horizontal, rear discharge
 ● 26 GA galvanized steel

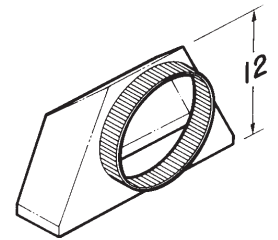

- Model T486 Transition**
 ● 8" round to 6" round
 ● 30 GA galvanized steel

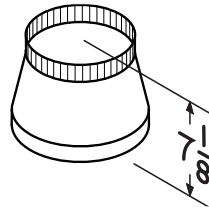

- Model 427 Transition**
 ● 4½" x 18½" to 10" round
 horizontal discharge
 ● 26 GA galvanized steel
 construction

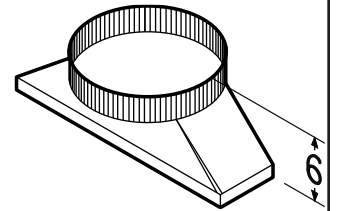

- Model T487 Transition**
 ● 8" round to 7" round
 ● 24 GA galvanized steel

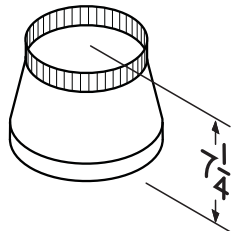

- Model 453 Transition**
 ● 4½" x 18½" to 10" round
 – horizontal, left discharge
 ● 26 GA galvanized steel

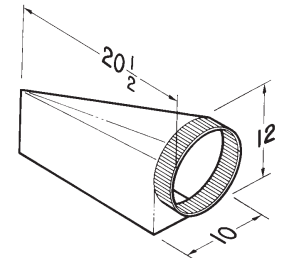

NOTE : All dimensions are in inches

- Model 454 Transition**
 ● Same as Model 453 except -
 horizontal right discharge

Broan-NuTone LLC Hartford, Wisconsin www.broan.com 1-800-637-1453 www.nutone.com 1-888-336-3948
Broan-Nutone Canada ULC, Mississauga, Ontario www.broan.ca www.nutone.ca 1-888-882-7626
BEST Hartford, Wisconsin www.BestRangeHoods.com 1-800-558-1711
BEST Drummondville, Québec www.BestRangeHoods.ca 1-866-737-7770

REFERENCE	QTY.	REMARKS	Project
			Location
			Architect
			Engineer
			Contractor
			Submitted by
			Date

Model 459 Transition

- 3 1/4" x 14" to 8" round - vertical discharge
- 30 GA galvanized steel construction

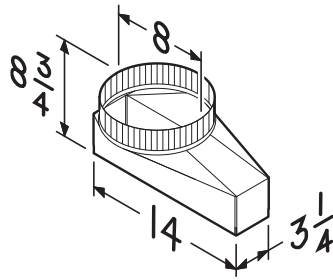

Model T460 Transition

- 3 1/4" x 14" to 7" round - vertical discharge
- 30 GA galvanized steel construction

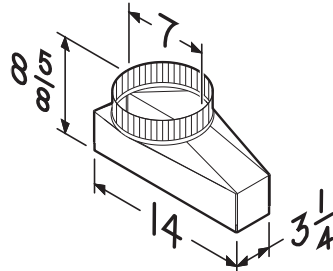

Model T462 Transition

- 3 1/4" x 14" to 6" round - vertical discharge
- 30 GA galvanized steel construction

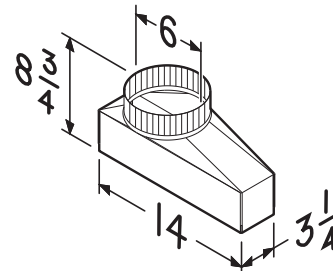

Model 472 Transition / Damper

- 10" round x 8" round
- Spring-loaded aluminum louvers
- Rubber stops
- 24 GA galvanized steel construction

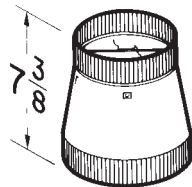

Model 475 Transition

- 6" round x 4" round
- Black, polymeric construction

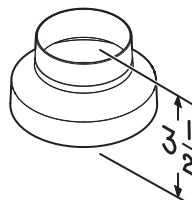

Model 475B Transition

- Six-pack of Model 475

Model 81212 Transition

- 8" x 12" to 12" round
- 28 GA galvanized steel construction

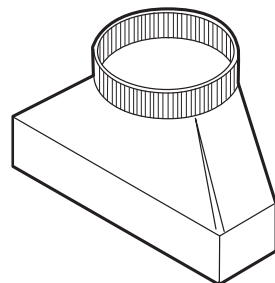

Model S99610015 Transition

- 8" x 12" to 10" round male - vertical discharge
- 26 GA galvanized steel construction

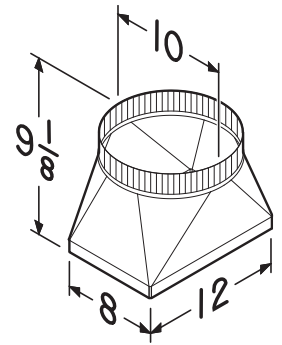

Model S99610028 Transition

- 8" x 12" to 10" round female - vertical discharge
- 26 GA galvanized steel construction

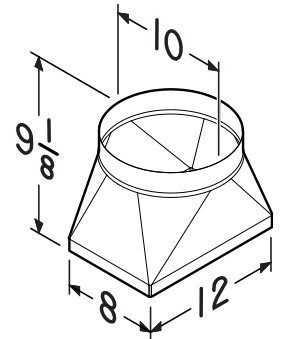

Model AVDKD8 Transition

Model ATKD8 Transition

- 1 7/8" x 19" to 8" round
- 26 GA galvanized steel construction
- Includes duct slips (Model ATKD8 only)
- Includes 2 barrel nuts for attachment (Model AVDKD8 only)

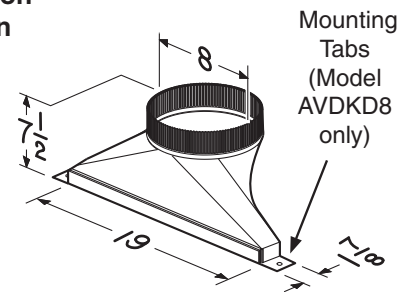

Model AVDKD10 Transition

Model ATKD10 Transition

- 1 7/8" x 19" to 10" round
- 26 GA galvanized steel construction
- Includes duct slips (Model ATKD10 only)
- Includes 2 barrel nuts for attachment (Model AVDKD10 only)

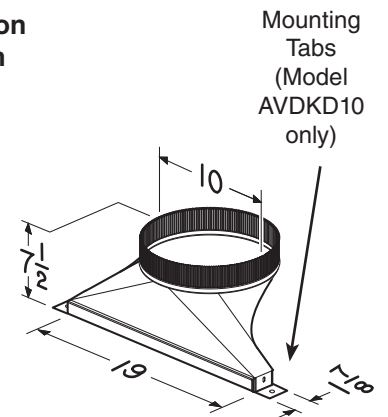

Broan-NuTone LLC Hartford, Wisconsin www.broan.com 1-800-637-1453
 Broan-Nutone Canada ULC, Mississauga, Ontario www.broan.ca 1-888-882-7626
 Broan-NuTone LLC Hartford, Wisconsin www.nutone.com 1-888-336-3948
 Broan-NuTone Canada ULC, Mississauga, Ontario www.nutone.ca 1-888-882-7626
 BEST Hartford, Wisconsin www.BestRangeHoods.com 1-800-558-1711
 BEST Drummondville, Québec www.BestRangeHoods.ca 1-866-737-7770

Model AVDKD8810

Model ATKD8810

Y-Duct Connector

- 10" to dual 8" round
- 26 GA galvanized steel construction

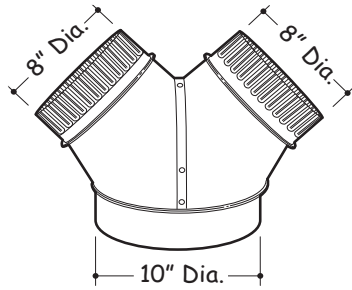

Model BP87 Damper

- 7" round
- Extruded steel with electrically-bonded epoxy finish
- .016 Aluminium louvers

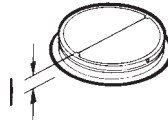

Model 421 Damper

- 10" round
- 24 GA galvanized steel with aluminum louvers

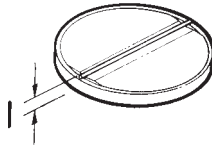

Model AVDKD219

Model ATKD219

- Adapts to 1 7/8" x 19" duct
- 22 GA galvanized steel construction
- Includes 2 barrel nuts for attachment

